

FIL3 Indoor Medium-Voltage SF6 Load Break Switch: LBS



فولمن
FULMEN



Content

- 1. About Us**
- 2. Load Break Switch Introduction**
- 3. FIL3 product overview**
 - 3.1. Advantages**
 - 3.2. Operation principle**
 - 3.3. Reliable production**
 - 3.4. Operating mechanism**
- 4. General Technical Specifications**
- 5. Product Components Selection Guide**
 - 5.1. Main items**
 - 5.2. Options**
 - 5.3. Designation and Codes**
 - 5.4. Accessories**
- 6. Overall Dimensions**
- 7. Handling and Transportation**

1. About us:



With more than 40 years of experience in Power Transmission and Distribution (T&D), Fulmen is nationwide known as a pioneer in many areas. Engineering, Procurement and Construction (E.P.C.), Power Quality and Manufacturing of HV, MV and LV Equipment and Apparatus are among the areas that Fulmen has been recognized for his crucial influence and works.

Thanks to the years of experience and the latest developed technology and unique equipment, we provide our customers with variety of products in the highest level of quality and technology

We in Fulmen, strongly believe that, based on the Organization values and vision, the door of opportunity to participate effectively in Industrial domain is open for us.

We are especially interested those areas which attend the real need of customers and ultimately affect mostly our society.

We consider Quality not as a choice, but as a Prerequisite. Without Quality, no business will be carried out by us.



2. Load Break Switch Introduction

A load break switch is a disconnect switch that has been designed to provide making or breaking of specified currents. This is accomplished by addition of equipment that increases the operating speed of the disconnect switch blade and the addition of some type of equipment to alter the arcing phenomena and allow the safe interruption of the arc resulting when switching load currents. Disconnect switches can be supplied with equipment to provide a limited load switching capability. Arcing horns, whips, and spring actuators are typical at lower voltages. These switches are used to de-energize or energize a circuit that possesses some limited amount of magnetic or capacitive current, such as transformer exciting current or line charging currents.

An air switch can be modified to include a series interrupter (typically vacuum or SF6) for higher voltage and current interrupting levels. These interrupters increase the load break capability of the disconnect switch and can be applied for switching load or fault currents of the associated equipment.

3. FIL3 Product Overview

FIL3 series of SF6 load break switches are applied for ring-main power system, making and breaking the load current and over-load current. It is a multi-function MV switch integrating the functions of load switch, earthing switch and disconnecter, embedded in a strengthened epoxy-resin-cast enclosure filled with SF6 gas as the arc extinguishing and insulation medium.

3.1. Advantages

FIL3 Series developed by **FULMEN** with cooperated with **DECOM** company. DECOM Technologies LBS, a world class German design, is upgraded, compact, reduced maintenance, easy to install and safe, also designed for being adopted with telecontrol applications, besides, it has following advantages:

- **Easy and Safe**
 - A three position switch to prevent incorrect operating
 - The earthing disconnecter has full closing capacity
 - Switching lever with an “anti-reflex” function
 - Integrated voltage indicator (Available)
 - Full interlocking system
 - Two inspection windows
 - Magnetic arc eliminator
 - Clear and animated display mimics

➤ **Economic Aspect**

- Low maintenance cost
 1. Pressure sealed system
 2. Enhanced electrical endurance on breaking operation
 3. Advanced design is intended to function with reduced maintenance under normal operating conditions
- Easy installation
 1. A solution adapted to cable connection
 2. Simplified switchboard busbar connection
- High mechanical endurance
- Long life cycle
- Compact size

3.2. Operating Principle

The switch may be in one of three positions: “closed”, “open”, or “earthed”, representing a natural interlocking system that prevents incorrect operation.

The device combines the breaking and disconnection functions.

The earthing switch placed in the SF6 has a short-circuit making capacity, in compliance with standards.

Moving-contact rotation is driven by a fast-acting mechanism that is independent of the action of the operator.

Mechanical and electrical controls are side by side available on the front fascia.

Close: the drive shaft is operated via a quick acting mechanism, independent of the operator. No energy is stored in the switch, apart from when switching operations are taking place.

For combined switch fuses, the opening mechanism is armed at the same time as the contacts are closed.

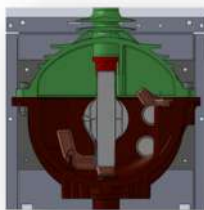

Open: the switch is opened using the same quick acting mechanism, operated in the opposite direction.

For a combined switch fuses unit, opening is controlled by a push-button or a fault.

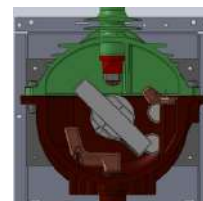

Earth: a specific control shaft enables the opening or closing of the earthing contacts. Access to this shaft is blocked by a cover that can be slide back if the switch is open but which remains locked in place if it is closed.



3.3. Reliable Production

FIL3 Load break switches are manufactured by employing deep knowledge on product and its detail parts, experienced skilled man power, strong documentation and advanced inspection equipment.



The factory routine tests are carried out on all products one by one according to relevant IEC standards. Also some of predefined tests are carried out on sample products and some important parts and subassemblies periodically, to obtain quality assurance requirements.



3.4. operating mechanism

- **Switchgear status indicator:**

Fitted directly to the drive shaft, these give a definite indication of the contact's position. (Appendix A of standard IEC 62271-102)

- **Operating lever:**

This is designed with an anti-reflex device that stops any attempt to re-open the device immediately after closing the switch or the earthing disconnecter. So it's also will be safe for operators.

- **Locking device (available by original cover):**

Between one and three padlocks enable the following to be locked:

- access to the switching shaft of the switch or the circuit breaker
- access to the switching shaft of the earthing disconnecter
- operating of the opening release push-button.

4. General Technical Specifications

FIL3 is available in two types of actuating mechanisms to provide wide range of customer's requirements, like fusible function.

- **LBS with K type mechanism (FIL3S):**

Single and Manual operation of LBS for switching

- **Switch function**

Independent-operation opening or closing by lever or motor

- **Earting-switch function**

Independent-operation opening or closing by lever.

Operating energy is provided by a compressed spring wich, when released, causes the contacts to open or close.

- **LBS with A type mechanism (FIL3D):**

Fusible function of disconnectivity

- **Switch function**

Independent-operation closing by lever and opening by push button.

Operating energy is provided by a compressed spring wich, when released, causes the contacts to open or close.

- **Earting-switch function**

Independent-operation opening and closing by lever.

Operating energy is provided by a compressed spring wich, when released, causes the contacts to open or close.

TECHNICAL SPECIFICATION



Item	Description	value	
1	Rated Voltage:	24KV	
2	Insulation level(50Hz, 1min: KV rms)	50KV	
3	Insulation level(1.2/50 μ s: KV peak)	125KV	
4	Isolation level(50Hz, 1min: KV rms)	60KV	
5	Isolation level(1.2/50 μ s: KV peak)	145KV	
6	Rated Normal Current	630A	
7	Rated active load breaking current	630A	
8	Rated closed loop breaking current	630A	
9	Rated line-charging breaking current	1A	
10	Rated cable-charging breaking current	10A	
11	Rated peak withstand current	40KA	
12	Rated short-time withstand current	16KA/1S	
13	Rated short- circuit making current	40KA	
14	Rated earth fault breaking current	30A	
16	Rated cable- charging breaking current under earth fault conditions	17.3A	
18	Number of poles	3	
19	Arc extinguishing medium	SF6	
20	Internal functional pressure of gas	0.4Bar	
21	Distance between poles	200mm	
22	Mechanical Endurance	Class M1	1000 Ops.
23	Electrical Endurance	Class E3	100 Ops.

Ambient condition:

- ✓ Altitude: \leq 1000m;
- ✓ Ambient temperature: -40°C to +70°C for stocking and -5°C to +40°C for operating;
- ✓ Relative humidity: daily average \leq 95%, monthly average \leq 90%;
- ✓ Occasions without flammable and explosive matter, without corrosive chemical and frequent severe vibration.

5. Product Components Selection Guide

5.1. Main Items (Basic order):

Switches	Description	Reference
	FIL3S LBS with K type operating mechanism	004-01
	FIL3D LBS with A type operating mechanism	004-02

5.2. Options:

FIL3S

- Motor
- Axulary Contacts in main path
- Axulary Contacts in earth path

Selection Guide Table For FIL3S options

Option	Spec.	Code	
<i>Motor⁽¹⁾</i>	24 VDC	M	1
	48 VDC		2
	110 VDC		3
	220 V, 50HZ		4
	110 V, 50HZ		5
	220 VDC		6
<i>Aux Contact</i>	2NO+2NC/main Switch	A	1
	4NO+2NC/main Switch		2
	2NO+2NC/ main Switch+2NO/Earth Switch		3
	4NO+2NC/ main Switch+2NO/Earth Switch		4

⁽¹⁾ 2NO+2NC/ main Switch Aux. Contacts are included.

FIL3D

- Motor
- Axulary Contacts in main path
- Axulary Contacts in earth path
- Shunt Coil

Selection Guide Table For FIL3D options

Option	Spec.	Code	
<i>Motor⁽¹⁾</i>	24 VDC	M	1
	48 VDC		2
	110 VDC		3
	220 V, 50HZ		4
	110 V, 50HZ		5
	220 VDC		6
<i>Aux Contact</i>	2NO+2NC/main Switch	A	1
	4NO+2NC/main Switch		2
	2NO+2NC/ main Switch+2NO/Earth Switch		3
	4NO+2NC/ main Switch+2NO/Earth Switch		4
<i>Shunt Coil</i>	24 VDC	S	1
	48 VDC		2
	110 VDC		3
	220 V, 50HZ		4
	110 V, 50HZ		5
	220 VDC		6

⁽¹⁾ 2NO+2NC/ main Switch Aux. Contacts are included.

5.3. Designation and Codes:

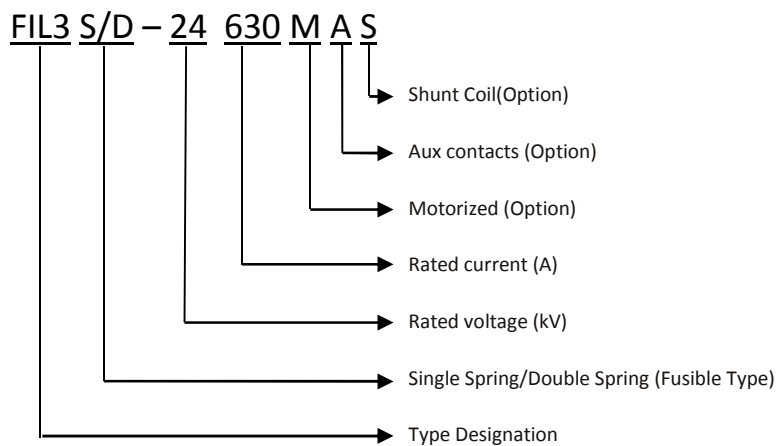

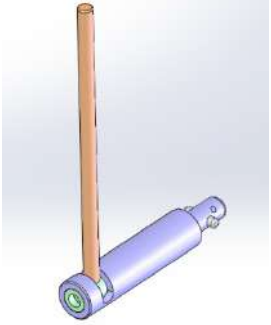

5.4. Accessories:

	Description		Reference
	Handle	Operating handle	4000-000

	Description		Reference
	DIVERS	Busbar field distributor	5000-000

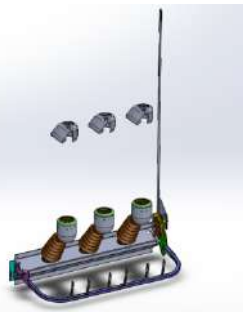
	Description		Reference
	Fuse trip system for fuse-switch		1000-000

	Description		Reference
	Earthing switch(2KA) With Capacitive Divider		2100-000
(No need to order 2000-000 and 2000-240)			

	Description		Reference
	Earthing switch(2KA) for Circuit Breaker module		2300-000
(No need to order 2000-240)			

	Description		Reference
	Field distributor/fuse holder for DIN fuses		2000-000

	Description		Reference
	Upper field distributor for cable connection		2010-000

	Description		Reference
	Capacitive divider/Insulator		2000-240
Post Insulator		2000-250	

	Description		Reference
	Front cover locking		7000-000

	Description		Reference
	Voltage presence indicator		8000-010

	Description		Reference
	SF6 pressure indicator		9000-000

6. Overall Dimensions

LBS – 24 kV:

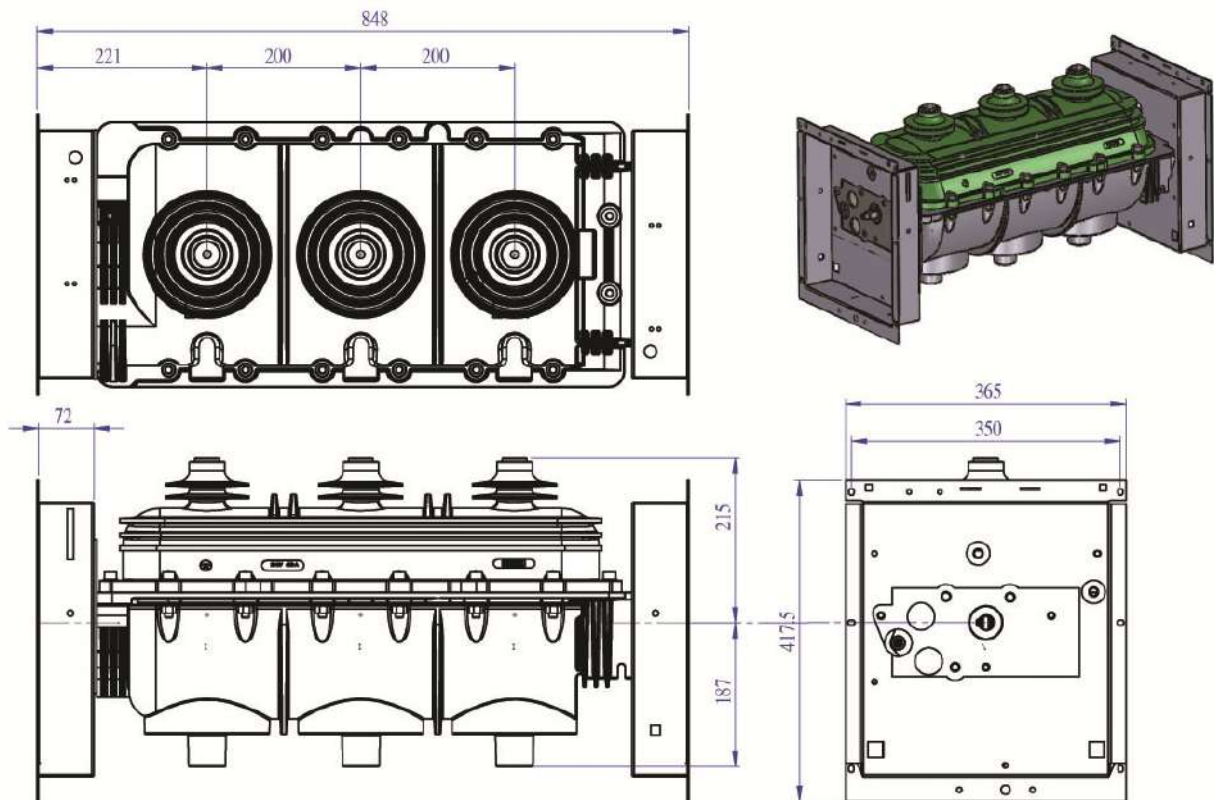

Packing Dimensions:

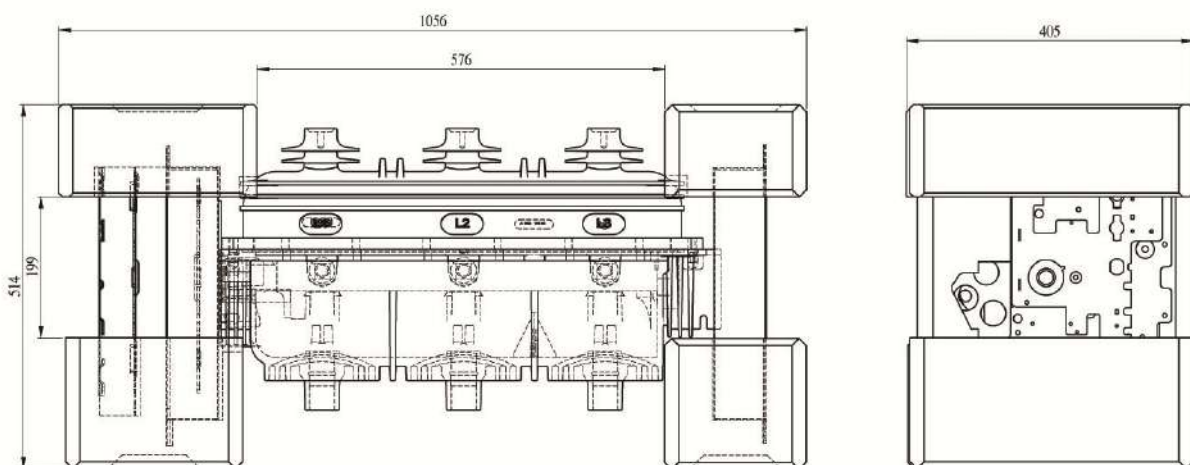

7. Handling and Transportation:

a) On main packing:



Strictly comply with the symbols and specifications on the packing.



b) After unpacking:



Handling by slings

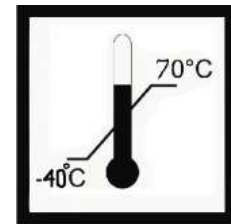

Fulmen Co.

No. 2, Danesh Alley, South MehrAbad
Tehran, IRAN

P.O. Box.: 19395/1371

T (+98 21) 6349 23 00 / 6349 25 88

F (+98 21) 6349 25 95

www.Fulmen.com

www.Panir-Co.com

info@Panir-Co.com